

PURE GLASS  
330

T  
CONCEPTS  
MIAMI

# PG-330 SYSTEM

## KEY FEATURES

- Improved soft-close (PureSoft) device utilizing gas in place of springs
- Increased system weight capacity of 330lbs
- Header track which accomodates a hydraulic patch fitting for swing doors
- Ease of installations. No pre-assembly required within header track prior to mount
- ADA compliant per lbs. of force used to operate
- Available in 2 series based on budget and required features
- EN testing over 100,000 cycles



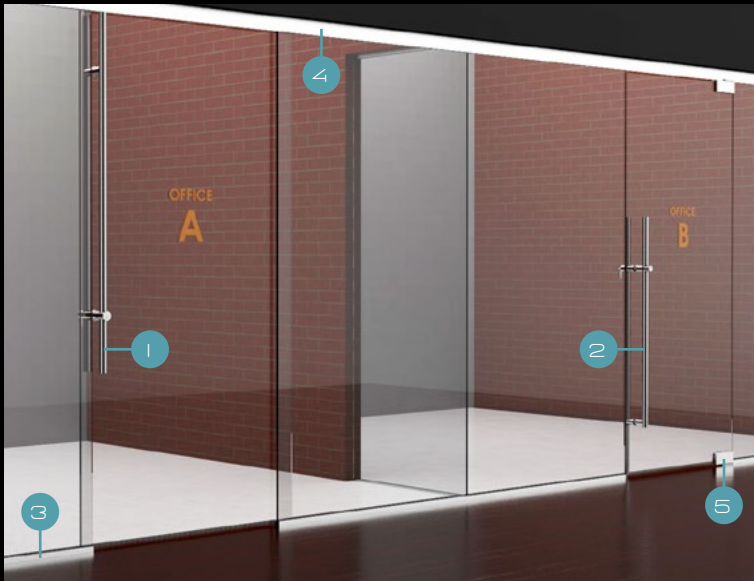

**1 LLNSP TOP LOCKING HANDLE**

- ADA compliant
- Brushed stainless steel
- SFIC or LFIC housing (corridor side)
- 108 deg 2-1/4" lever turn (inside)



**5 HYDRAULIC-ASSIST AUTO PATCH HINGES**

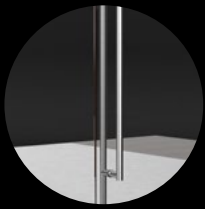

**2 URHD STAGGERED LOCKING HANDLE**

- ADA compliant
- Brushed stainless steel
- SFIC or LFIC housing (corridor side)
- 108 deg 2-1/4" lever turn (inside)

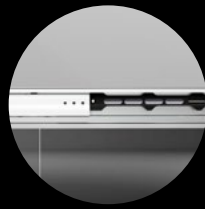

**6 CLAMP ASSEMBLY INCLUDES**

- Stop/retainer assembly
- Shock absorber
- Clamp body
- Gas assist soft close (PureSoft)
- Soft close trigger



**3 ANODIZED ALUMINUM BOTTOM TRACK**

- Accomodate fixed glass panels
- Black/grey gaskets

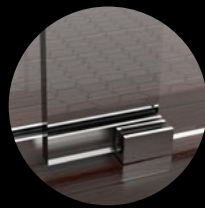

**7 SLIDING DOOR FLOOR GUIDE**

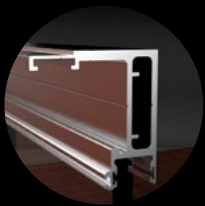

**4 ANODIZED ALUMINUM TOP TRACK**

- Accomodate fixed and sliding glass
- Black/grey gaskets

Available in Brushed Stainless Steel (BSS) and Matte Black (MBLK)

# TYPICAL INSTALLATIONS

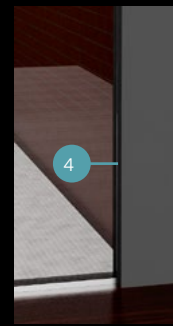
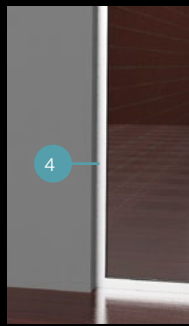
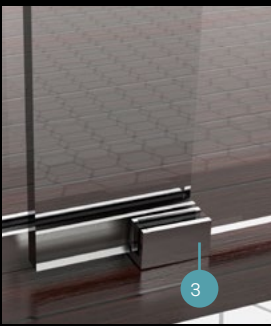
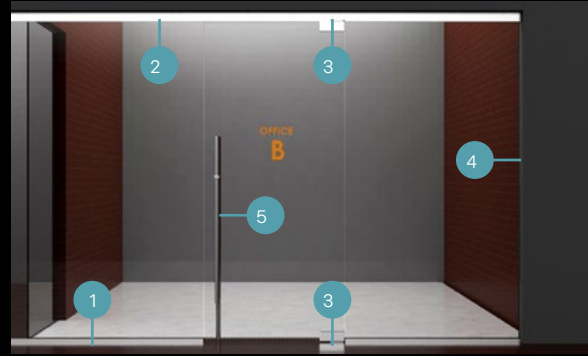
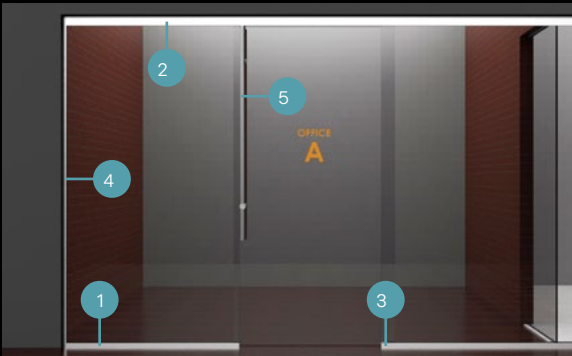

## OFFICE A FEATURES

- 1 Anodized aluminum bottom track
- 2 Anodized aluminum top track
- 3 Floor guide
- 4 Vertical track
- 5 ADA compliant top locking handle with supplied SFIC or LFIC lock housing

## OFFICE B FEATURES

- 1 Anodized aluminum bottom track
- 2 Anodized aluminum top track
- 3 Pivot hydraulic-assist Auto Patch hinges
- 4 Silicone joint
- 5 ADA compliant, staggered bottom locking handle with supplied SFIC or LFIC lock housing

# BULKHEAD FIXING

BULKHEAD FIXING WITH SIDELIGHTS SINGLE DOOR

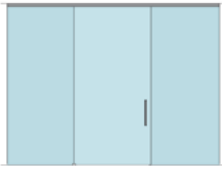

BULKHEAD FIXING WITH SIDELIGHTS DOUBLE DOORS

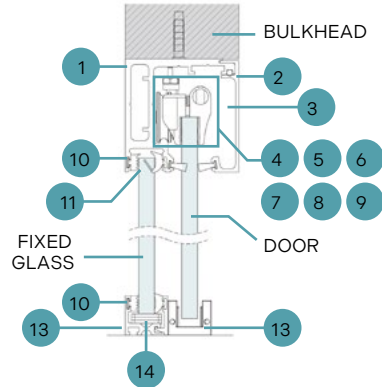
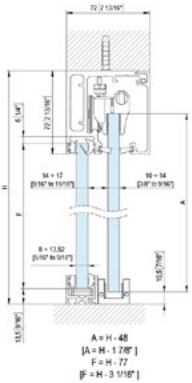

CLAMP OPTION A: SOFT-CLOSE

- Door Width  $\geq$  40"
- Note: 2 sets are required per door

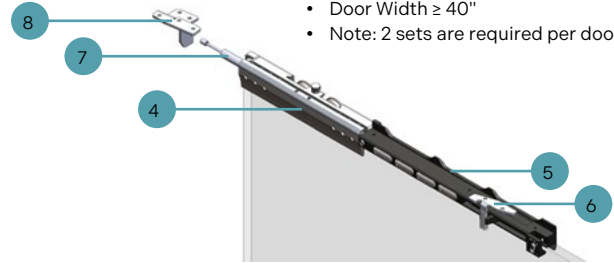

CLAMP OPTION B: ADA

- Door Width < 40"
- Note: 2 sets are required per door

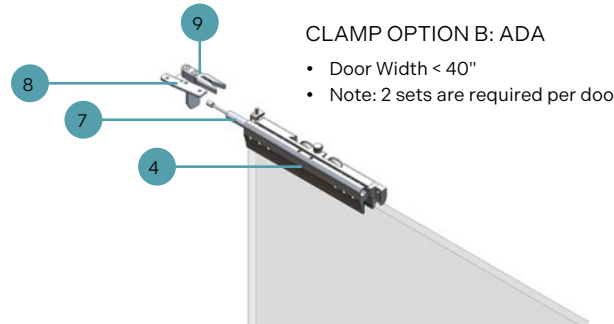

## SYSTEM BILL OF MATERIALS

	P/N	DESCRIPTION	STOCK LENGTH	REQUIRED QTY	WITH CLAMP OPTION A	WITH CLAMP OPTION B
1	B330EP43/12602	Header Track	126"	Per Opening Size & Door Type	X	X
2	B330EP44/12602	Header Valence	126"	Per Opening Size & Door Type	X	X
3	B330EP62-19	Internal End Cap	-	2	X	X
4	B330EK1007	Clamp Kit (2ea)	-	Per Door Type	X	X
5, 6, 7, 8	B330EK3SS00	Soft-Close/Anti-Shock/Stop Kit (Option A)	-	Per Door Type & Clamp Option	X	
7, 8, 9	B330EK3AA00	Anti-Shock/Stop/Retainer Kit (Option B)	-	Per Door Type & Clamp Option		X
10	P20EJ1113	Gasket (12.7mm – Pre-Gasket + Final Gasket)	126"	Per Opening Size & Door Type	X	X
11	B330E45/02	Track Cover – Fixed Glass	126"	Per Opening Size	X	X
12	B110WP50/02	Door Guide	-	Per Door Type	X	X
13	P20E28/02	P20 Base Track	114"	Per Opening Size	X	X

Additional PG330 system details [here](#)



HEADER TRACK

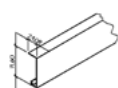

HEADER VALENCE



INTERNAL END CAP



CLAMP KIT - OPTION A



CLAMP KIT - OPTION B (ADA)



GASKET - 12.7MM



TRACK COVER FIXED GLASS

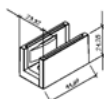

DOOR GUIDE

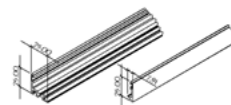

P20 BASE TRACK



SHIM



# HANDLE OPTIONS



XP

LP

LLNSP

URHD  
(Universal Rim  
Housing Design)

- All handles are available in standard sizes or custom sizes
- Material: 304 S.S.
- Finish: Brushed Stainless Steel (BSS), Polished Stainless Steel (PSS), Matte Black (MBLK), Oil Rubbed Bronze (ORB), Titanium Black (TBLK), White (WHT) – NOTE: Custom Colors Available - Inquire.
- Locking options: Thumb turn, ADA-lever turn, SFIC or LFIC housing
- Locking position: bottom locking, top locking
- ADA or non-ADA design
- Non-locking "XP" interchangeable handles available

## TCM ANTIMICROBIAL HANDLES

As part of our unwavering commitment to create clean and sustainable work environments, we partnered with Microban® to provide ultimate door handle protection.

PROTECTED BY  
**MICROBAN**



# ABOUT T CONCEPTS MIAMI

T CONCEPTS MIAMI (TCM) is a Miami-based manufacturer of architectural door hardware. Our firm specializes in locking ladder pulls, non-locking ladder pulls, custom pull handles, ADA compliant hardware, hydraulic hinges + patch fittings, along with complete, revolutionary environments' solutions. TCM services clients throughout North and South America, and Europe.

T CONCEPTS MIAMI has taken a long look at the glass hardware industry...and decided it's time for a transparent evolution.

For more information, visit us online or contact us directly.



**REQUEST A QUOTE**

[RFQ@T-CONCEPTS.COM](mailto:RFQ@T-CONCEPTS.COM)



**CONTACT US**

[T-CONCEPTS.COM](http://T-CONCEPTS.COM) | 888.409.9340  
[HELLO@T-CONCEPTS.COM](mailto:HELLO@T-CONCEPTS.COM)