

PURE GLASS  
90

T

CONCEPTS  
MIAMI

# PG-90 SYSTEM

## INSTALLATION PLAN

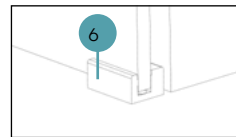
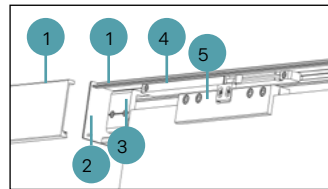
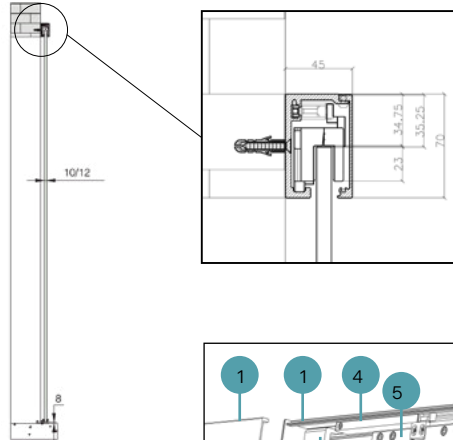
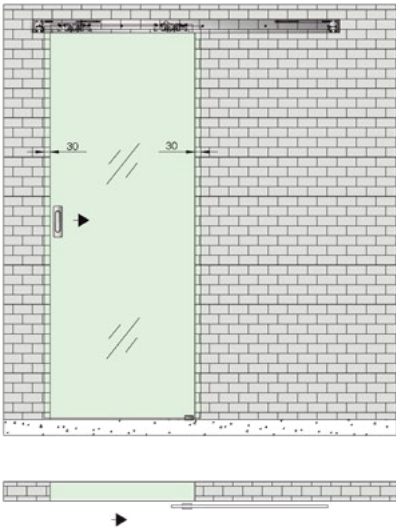

## KEY FEATURES

- Proven super quiet operation
- Minimal header track design
- Soft close technology
- Ease of installation
- Transom mounting option
- Bi-parting door option
- Maximum weight: 100KG

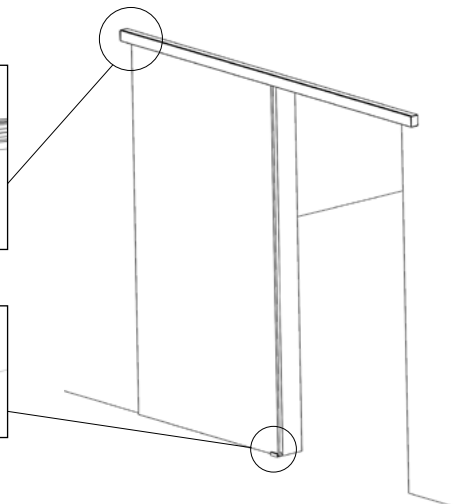

## SYSTEM BILL OF MATERIALS

	DESCRIPTION	P/N	QTY	LENGTH
1	Headertrack/Valence	SA8600B-20	1	118"
2	Endcap	SA8620A-4L/R	1	-
3	Stop	SA8620A-3	2	-
4	Soft-Close Device	SA8620A-2	2	-
5	Clamp	SA8620A-1	2	-
6	Door Guide	SA8600E-4	1	-

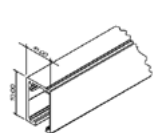

HEADER TRACK/  
VALANCE

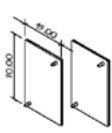

END CAP

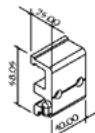

STOP

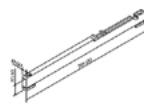

SOFT-CLOSE  
DEVICE

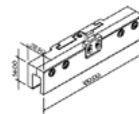

CLAMP

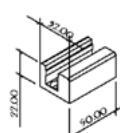

DOOR GUIDE

Available in Brushed Stainless Steel (BSS) and Matte Black (MBLK)

# ABOUT T CONCEPTS MIAMI

T CONCEPTS SOLUTIONS (TCM) is a Miami-based manufacturer of architectural door hardware. Our firm specializes in locking ladder pulls, non-locking ladder pulls, custom pull handles, ADA compliant hardware, hydraulic hinges + patch fittings, along with complete, revolutionary environments' solutions. TCM services clients throughout North and South America, and Europe.

T CONCEPTS MIAMI has taken a long look at the glass hardware industry...and decided it's time for a transparent evolution.

For more information, visit us online or contact us directly.



**REQUEST A QUOTE**

[RFQ@T-CONCEPTS.COM](mailto:RFQ@T-CONCEPTS.COM)



**CONTACT US**

[T-CONCEPTS.COM](http://T-CONCEPTS.COM) | 888.409.9340  
[HELLO@T-CONCEPTS.COM](mailto:HELLO@T-CONCEPTS.COM)